

Georgia Tech School of Electrical and Computer Engineering

[2019-2020 Annual Report]

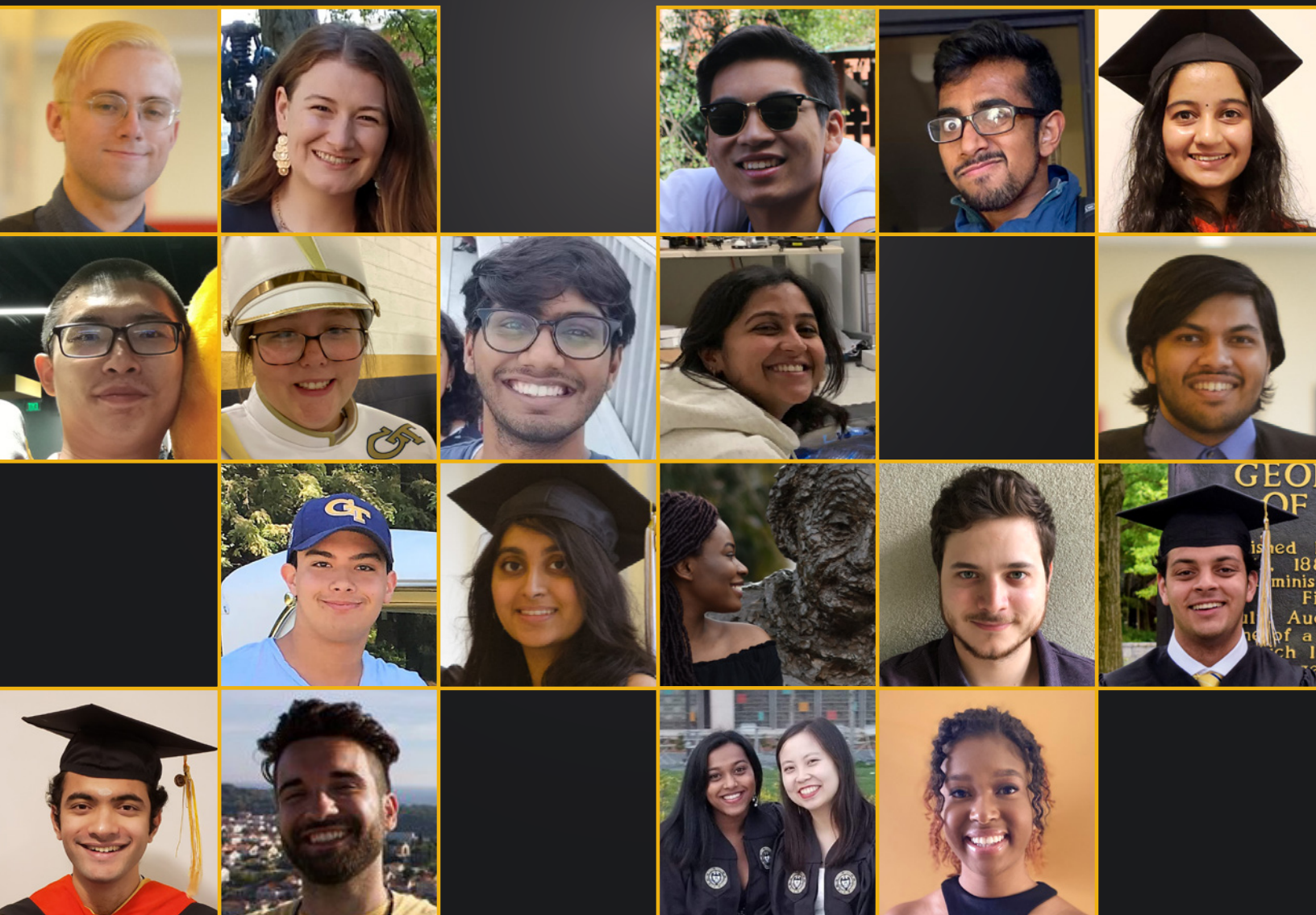



I am proud to present the 2019-2020 annual report for the Georgia Tech School of Electrical and Computer Engineering (ECE). This report displays the diverse range of activities and accomplishments of our faculty, staff, students, and alumni prior to the emergence of the coronavirus and how we have managed to make lemonade from a big, sour pandemic lemon since last spring.

The cover of this year's annual report is dedicated to our students who graduated last spring. I admire their resilience in how they rose to the challenges brought on by Covid-19. They and our students who are now navigating their way through the 2020-2021 academic year are incredible, and they all have my unequivocal support and respect.

In the last year, we have worked hard to become more visible and welcoming to the entire metro Atlanta community, to learn how we can help, and to show why what we do matters. Our work, whether directly related to Covid-19 or not, addresses real needs and provides solutions to the myriad issues facing our world today. Those include, but are certainly not limited to, the development of biomedical devices and testing capabilities, deployment of tools and techniques that

make using cyberspace more secure, and using robotics and electronics in an unlimited number of ways.

While we have all been apart since last spring and are back on campus sporadically this fall, I feel that our faculty, staff, and students have become closer in many ways, and that also holds true for our relationships with alumni, corporate and government partners, and friends. I have enjoyed meeting with you both in person and virtually during this last year.

Once this pandemic is under control and behind us, I sincerely hope that we can all take the lessons learned during this time and keep them as a part of our lives. It is an honor to work with you and to have you as part of the ECE family. Please do not hesitate to contact me if we can be of service or if you would like to join us in our efforts to make our world a better place.

Sincerely,

Magnus Egerstedt
Professor and Steve W. Chaddick School Chair

[+] ECE Overview



[RANKINGS]

U.S. News & World Report
Graduate and Undergraduate
Rankings

#4

E.E. undergraduate
program

#5

Cmp.E. undergraduate
program

#6

E.E. graduate program

#6

Cmp.E. graduate program



[ENROLLMENT]

2,617

overall total

1,326

total undergraduate
enrollment, FY 20

700 B.S.E.E.

626 B.S.Cmp.E.

21% female
18% underrepresented
minorities

1,291

total graduate enrollment,
FY 20

617 M.S.E.C.E.
4 M.S. Bioengineering
50 M.S. Cybersecurity
560 Ph.D. E.C.E.
10 Ph.D. Bioengineering
15 Ph.D. Machine Learning
33 Ph.D. Robotics
2 Non-degree seeking

18% female
8% underrepresented
minorities



[DEGREES]

872

overall total

384

total undergraduate
degrees awarded, FY 20

197 B.S.E.E.

187 B.S.Cmp.E.

20% female
18% underrepresented
minorities

488

total graduate degrees
awarded, FY 20

2 M.S. Bioengineering
2 M.S. Cybersecurity
395 M.S.E.C.E.
2 Ph.D. Bioengineering
83 Ph.D. E.C.E.
4 Ph.D. Robotics

19% female
5% underrepresented
minorities

[+] Coronavirus Pandemic Spurs ECE Ingenuity

On March 16, 2020, the Georgia Tech campus in Atlanta was closed for all non-essential business due to the global coronavirus pandemic. Two weeks later and for the first time in the Institute's 136-year history, in-person classroom instruction was moved online. The campus was quiet and sparsely populated, but behind the scenes, ECE personnel used their knowledge and resources to provide equipment to healthcare workers and develop a novel new testing procedure that could be a game-changer in the fight against Covid-19.

"The situation has definitely presented challenges to the way we typically do things, but it is also providing a real-life opportunity for us to prove our worth as innovators. Times like these are why we are here, why we do what we do. I couldn't be prouder of how the ECE community has risen to the current challenge," said Magnus Egerstedt, Steve W. Chaddick School Chair and Professor in the School of ECE.

One of the most immediate needs was the shortage of Personal Protective Equipment (PPE) at Atlanta-area hospitals. The entire campus sprang into action to collect and donate PPE. The Institute for Electronics and Nanotechnology (IEN), led by ECE Professor Oliver Brand, donated cleanroom gowns, chemical-resistant gloves, aprons, caps, shoe covers, face shields and masks, safety glasses, and isopropanol to Emory University Hospital. The effort was coordinated by IEN staff members Charlie Turgeon and Dean Sutter and resulted in 55 cases of equipment being donated.

In the Interdisciplinary Design Commons (IDC) makerspace, Kevin Pham, IDC director, and Ian Heaven, an ECE graduate teaching assistant, used 3D printers to print valves to retrofit a scuba mask and turn it into a Bilevel Positive Airway Pressure (BiPAP) device. The IDC team also worked with Shannon Yee, an associate professor in the George W. Woodruff School of Mechanical Engineering, to fabricate circuit boards for ventilators and to test a prototype.

On the diagnostic side, Manos Tentzeris, the Ken Byers Professor in Flexible Electronics, research scientist Yunnan Fang, and graduate students from Tentzeris' ATHENA research team worked on a cutting-edge means to test for coronavirus that uses ink jet technology and antibodies and proteins to create ultra-scalable, safer, quicker, and more accurate testing. The Phase 1 tests

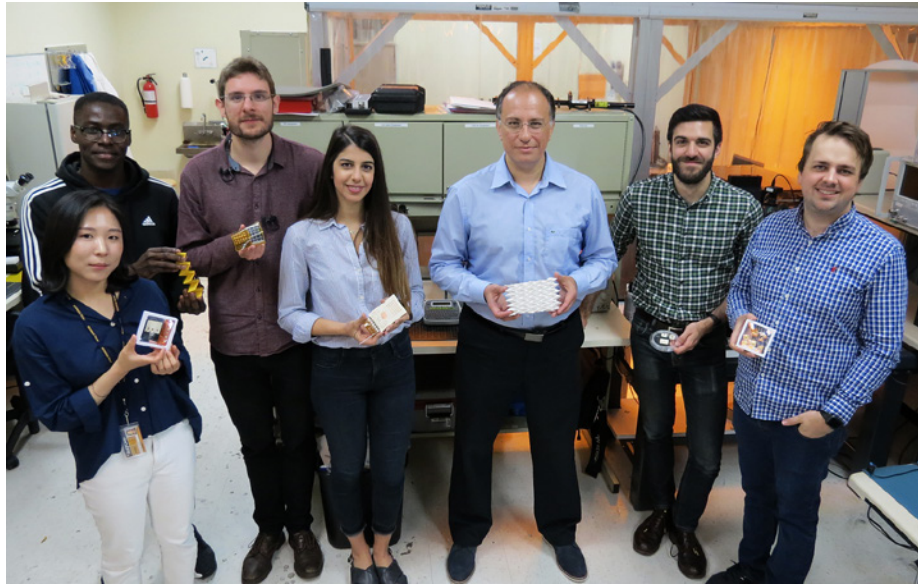

using Covid-19 antibodies supplied by Emory University's Microbiology Department were successful, demonstrating the fastest detection time of two minutes and were concluded in early June. Phase 2 testing with plasma and blood serum began in September 2020. If subsequent testing goes well, the test will be submitted to the U.S. Food and Drug Administration for approval.

Even more ECE faculty, staff, students, and alumni answered the call to be of service to Georgia Tech, the metro Atlanta area, and beyond. Faculty heeded this need in different ways, ranging from ECE Assistant Professor Brendan Saltaformaggio providing [cyber hygiene tips](#) for employees suddenly finding themselves teleworking every day to Brand working with a local, multi-institutional team helping [to evaluate potential Covid-19 tests](#). Brian Singer (CmpE '20) helped in the development of [low-cost emergency ventilators](#) and Gregory Kolovich (EE '04) and Evan Ruff (CmpE '03, MBA '07) worked on [a deployable chest x-ray device for diagnoses and testing](#). And students like JC Chun found [ways to continue research activities remotely](#).

"These times are a test of our ingenuity, flexibility, and resourcefulness. We must not only be resilient, but audacious. This is an incredibly difficult time for our global community, but I believe the next great set of inventions will be born from these challenges and they will come from the minds and hearts of engineers and scientists," said Egerstedt.

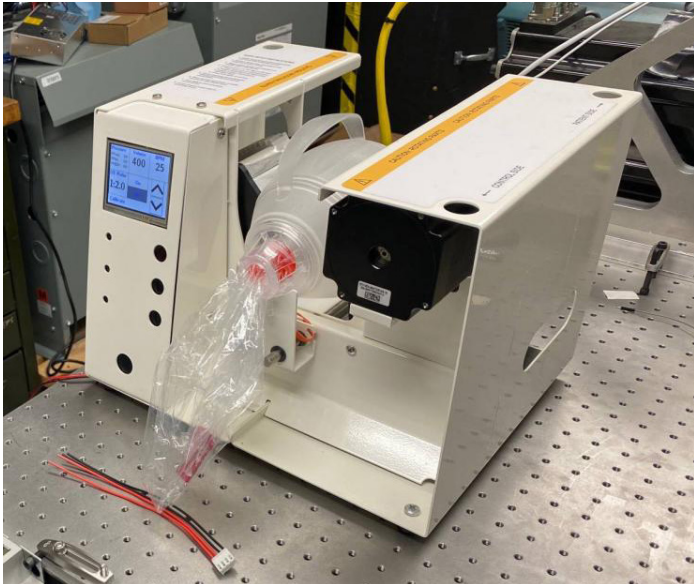

“Times like these are why we are here, why we do what we do. I couldn’t be prouder of how the ECE community has risen to the current challenge.”

MAGNUS EGERSTEDT



Clockwise from top left: An emergency ventilator developed by alumnus Brian Singer. Alumnus Dr. Gregory Kolovich with the chest x-ray device. PPE collected by the IEN for Emory University Hospital. Ji Ye (JC) Chun continues her experimental research in her apartment. Opposite page: Manos Tentzeris (center) and the ATHENA research team.

[+] Faculty & Staff

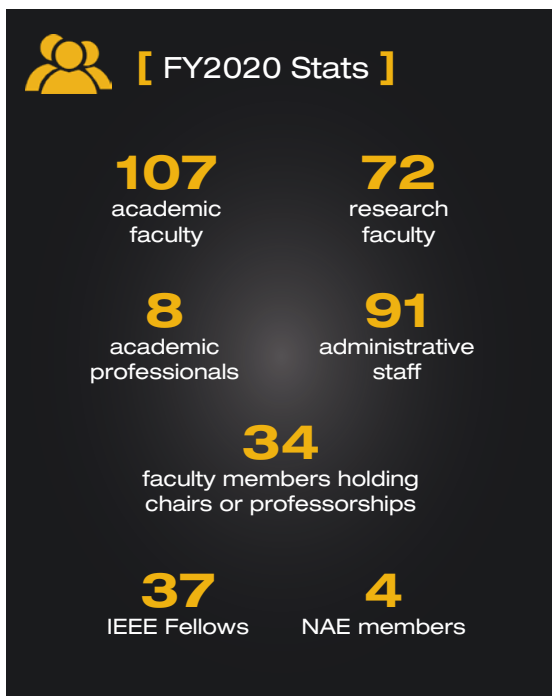

[New Faculty]



David Frakes
Associate Professor
Bioengineering
*Joint Appointment with the
Wallace H. Coulter Department
of Biomedical Engineering*



Shaolan Li
Assistant Professor
Electronic Design and
Applications

[Faculty Awards]

ECE faculty members were honored by Georgia Tech and at the state, national, and international levels for their excellence in teaching, advising and mentoring, research, professional service, and commercialization.

External Awards

Azadeh Ansari | [NSF CAREER Award](#)

Vincent Calhoun | [IEEE Engineering in Medicine and Biology Society Technical Achievement Award](#)

Edward Coyle and the Vertically Integrated Projects Program | [ABET Innovation Award](#)

Mark Davenport | [Presidential Early Career Award for Scientists and Engineers](#)

Russell Dupuis | [Materials Today Innovation Award](#)

Stanislav Emelianov | [IEEE Fellow](#)

Felix Herrmann | [Society of Exploration Geophysicists Reginald Fessenden Award](#)

Anna Holcomb | [Governor's Teaching Fellows Program](#)

Tushar Krishna | [IEEE Micro Top Pick](#)

A.P. Sakis Meliopoulos | [Doctor Honoris Causa, School of Electrical and Computer Engineering, National Technical University of Athens \(Greece\)](#)

Saibal Mukhopadhyay | [Intel Outstanding Researcher Award](#)

Arijit Raychowdhury | [Top Pick in Hardware and Embedded Security; Qualcomm Faculty Award](#)

Ajeet Rohatgi | [Distinguished Alumnus Award, Indian Institute of Technology Kanpur](#)

Erik Verriest | [Giovanni Prodi Chair in Mathematics, Ludwig Maximilian University](#)

Hua Wang | [DARPA Director's Fellowship](#)

Shimeng Yu | [Semiconductor Research Corporation Young Faculty Award](#)

Georgia Tech Awards

Muhannad Bakir | [Outstanding Doctoral Thesis Advisor Award](#)

Jeffrey Davis | [Class of 1934 Outstanding Innovative Use of Education Technology Award](#)

Ayanna Howard | [Outstanding Achievement in Research Innovation Award](#)

Linda Wills | [Class of 1940 W. Howard Ector Outstanding Teacher Award](#)

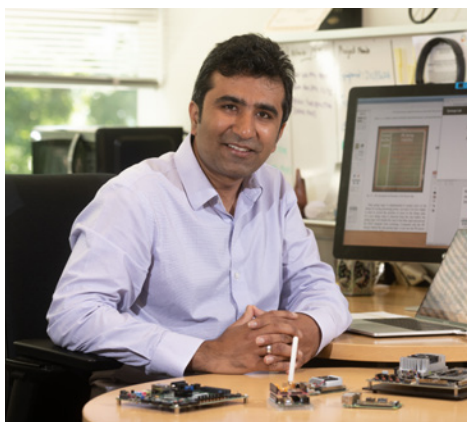
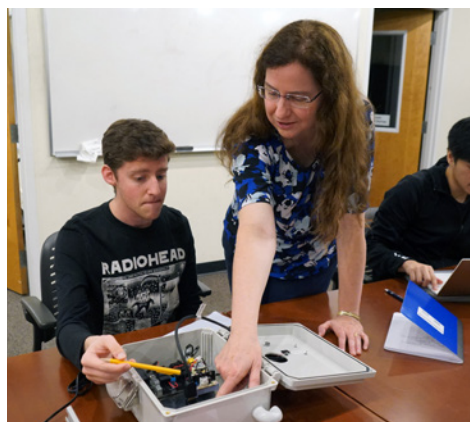

From left: Linda Wills working with a student, Tushar Krishna, and Mark Davenport (left) receiving the PECASE Award from Dr. Kelvin Droegemeier, director of the White House Office of Science and Technology Policy

[+] Students & Student Groups



ECE Students Participate in 34 Teams during Fall 2019 Capstone Design

One hundred and forty-three teams from seven schools and two colleges competed for prizes at the Fall 2019 Capstone Design Expo as students showcased their senior projects. The event was held on December 2 at McCamish Pavilion on the Georgia Tech campus.

Of the 143 teams participating, ECE was represented by 16 teams in the ECE discipline-specific category and by 18 teams in the interdisciplinary category.

The ECE disciplinary award was presented to “Backup Key Generation for Encrypted Website Data.” This service will bridge the gap between the two major approaches to handling user data today, providing both the security of fully encrypting user data to protect it from data breaches and other cyberattacks while still allowing users to recover access to the data if they forget their password.

The team was a mixture of ECE majors. The computer engineers included Trenton Bruno, Michael Brzozowski, Kee Hong, Matthew Lewis, and Matthew Riley, and the electrical engineering majors included Reid Barton and Maddy Parnall.



Virtual Graduation in ECE

On May 6, 2020, the School of ECE hosted a Facebook Premiere Party to celebrate all of our graduating students.

The video featured photos and videos of our graduates and greetings from the ECE faculty, staff, administration, and advisory board, plus special messages from Nicholas Joaquin and Louise Zhuang, representing the computer engineering and electrical engineering seniors respectively, and Alexander Akins representing the ECE graduate students.

We wish all of our graduates the very best in their very bright futures. Please come back to visit and stay in touch with us!

ECE student groups provide outlets for community building, K-12 outreach and service, and professional development. Our students also participate in interdisciplinary clubs and many social, professional, and cultural organizations at Georgia Tech.

[Student Groups]

[ECE Ambassadors](#) • [ECE Graduate Student Organization](#) • [Eta Kappa Nu](#) • [The Hive](#)
[Georgia Tech IEEE](#) • [Women in Electrical and Computer Engineering](#)

[Award Winners]

Our students received awards through the Roger P. Webb Awards Program and different campus awards programs. This past spring, Lillian Anderson received the highest accolade presented to an undergraduate female engineering student.

Georgia Tech Awards

Lillian Anderson | [Helen Grenga Outstanding Woman Engineer Award](#)

Grayson Eady | [Billiee Pendleton-Parker Award for Outstanding Allyship](#)

Mingu Kim | [Sigma Xi Best Ph.D. Thesis Award](#)

Andrew Gauker, Tolga Ustuner | [College of Engineering Honors Day Awards](#)

Roger P. Webb Awards

Louise Zhuang | [Outstanding Electrical Engineering Senior Award](#)

Nicholas Joaquin | [Outstanding Computer Engineering Senior Award](#)

Kartik Sastry, Matthew Denton | [ECE Graduate Teaching Assistant Excellence Awards](#)

Mohammad Taghinejad, Siddharth Varughese | [ECE Graduate Research Assistant Excellence Awards](#)



Lillian Anderson (left) and Mingu Kim.

[+] Student Stories



Team Canary Wins People’s Choice Award at 2020 InVenture Prize

Two teams with ECE students — Canary and Watchdog — were among the six finalists for the 2020 InVenture Prize, held on March 11 at the Ferst Center for the Arts. [Canary won the \\$5,000 People’s Choice Award](#) at this event, which celebrated its twelfth year this spring.

[Canary](#) (top left photo) is a platform for students to share reviews of their internship and co-op experiences with their peers and employers. The team was made up of Sims Pettway (mechanical



engineering), Stephen Ralph, Jr. (computer engineering), and Noah Waldron (computer science).

[Watchdog](#) (top right photo) is a portable security device for students and telecommuters to protect their personal belongings in public spaces when they need to step away. The team consisted of Hannah Blankenship and Nicolette Sam (electrical engineering); Jason Diaz, Ryan Faddell, and Cole Otto (mechanical engineering); and Mehnaz Ruksana (computer science).



Eta Kappa Nu Receives Outstanding Chapter Award

The Beta Mu chapter of [Eta Kappa Nu](#) at Georgia Tech was among 26 chapters nationwide to be chosen for a 2018-2019 Outstanding Chapter Award by the [IEEE-Eta Kappa Nu \(HKN\) national office](#).

Among their numerous activities, the Georgia Tech HKN students coordinate the “Lab Kits Sales” program. These kits provide the needed components for required ECE undergraduate laboratories and non-major laboratories. Costing less than the corresponding commercial components, the kits have saved ECE students tens of thousands of dollars over the last decade.

The HKN students make a net profit from their sales and use the funds to establish two endowed scholarships for ECE students. With their current income, each year they award a \$1,000 scholarship to a deserving junior and a \$1,000 scholarship to a student who demonstrates entrepreneurship.



The Woman Behind the Wheel of a Georgia Tech Icon

It is a moment that can put a smile on any Yellow Jacket’s face — walking to class, you hear the familiar aooogah of a horn, turn, and see the Ramblin’ Wreck driving down Skiles on its way to the Campanile.

The 1930 Ford Model A sport coupe is the beloved mechanical mascot of Georgia Tech. Purchased in 1960, the classic car has been cared for and maintained by members of the [Ramblin’ Reck Club](#) since 1967. The Ramblin’ Reck Club consists of 50 student body members who act as the official ambassadors of school spirit and tradition on campus.

The driver of the Ramblin’ Wreck comes from the Club’s ranks. During 2020, that driver was Abi Ivmeyer, a third-year electrical engineering major from Snellville, Georgia. Growing up in a Tech family, some of her earliest memories are going to football games at Bobby Dodd Stadium and her school spirit is tied to that legacy.

[+] Research & Education Highlights



[‘SlothBot in the Garden’ Demonstrates Hyper-Efficient Conservation Robot](#)

For the next several months, visitors to the [Atlanta Botanical Garden](#) will be able to observe the testing of a new high-tech tool in the battle to save some of the world’s most endangered species. SlothBot, a slow-moving and energy-efficient robot that can linger in the trees to monitor animals, plants, and the environment below, is being tested near the Garden’s popular Canopy Walk.

Built by engineers in ECE’s [Georgia Robotics and Intelligent Systems Laboratory](#) to take advantage of the low-energy lifestyle of real sloths, SlothBot demonstrates how being slow can be ideal for certain applications. Powered by solar panels and using innovative power management technology, SlothBot moves along a cable strung between two large trees as it monitors temperature, weather, carbon dioxide levels, and other information in the Garden’s 30-acre midtown Atlanta forest.

About three feet long, SlothBot’s whimsical 3D-printed shell helps protect its motors, gearing, batteries, and sensing equipment from the weather. The robot is programmed to move only when necessary, and will locate sunlight when its batteries need recharging. At the Atlanta Botanical Garden, SlothBot will operate on a single 100-foot cable, but in larger environmental applications, it will be able to switch from cable to cable to cover more territory.

[Lung-Heart Super Sensor on a Chip Tinier Than a Ladybug](#)

During a stroll, a woman’s breathing becomes a slight bit shallower, and a monitor in her clothing alerts her to get a telemedicine check-up. A recent study details how a sensor chip smaller than a ladybug records multiple lung and heart signals, along with body movements, and could enable such a future socially distanced health monitor.

The core mechanism of the chip developed by ECE researchers involves two finely manufactured layers of silicon, carrying a minute voltage and overlaying each other separated by the space of 270 nanometers. This research team is led by [Farrokh Ayazi](#), a Ken Byers Professor in ECE.

Vibrations from bodily motions and sounds put part of the chip in very slight motion, making the voltage flux, thus creating readable electronic outputs. In human testing, the chip recorded a variety of signals from the mechanical workings of the lungs and the heart with clarity, signals that often escape meaningful detection by current medical technology.

The chip, which acts as an advanced electronic stethoscope and accelerometer in one, is aptly called an accelerometer contact microphone. It detects vibrations that enter the chip from inside the body while keeping out distracting noise from outside the body’s core like airborne sounds.

The detection bandwidth is enormous — from broad, sweeping motions to inaudibly high-pitched tones. Thus, the sensor chip records all at once fine details of the heartbeat, waves the heart sends through the body, and respiration rates and lung sounds. It even tracks the wearer’s physical activities such as walking. The signals are recorded in sync, potentially offering the big picture of a patient’s heart and lung health.

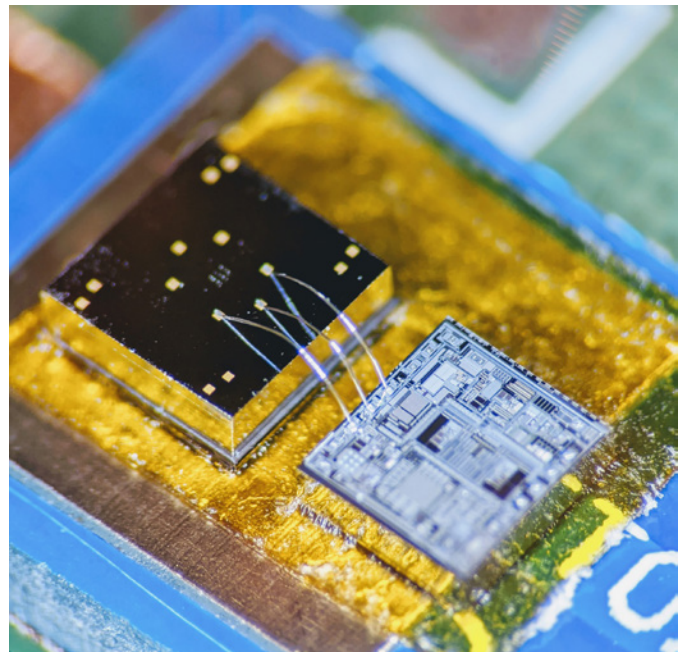

[+] Research & Education Highlights

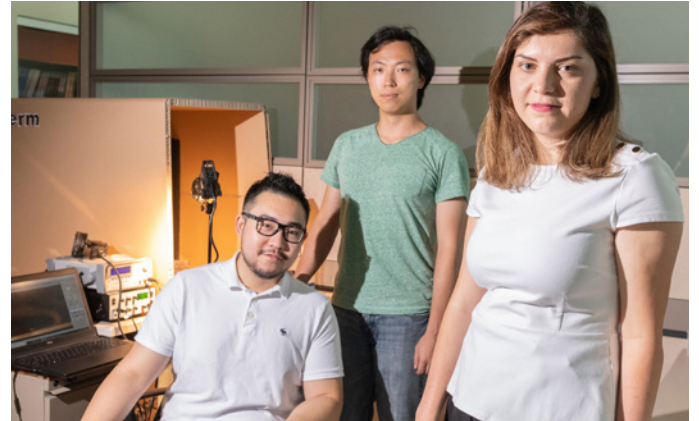
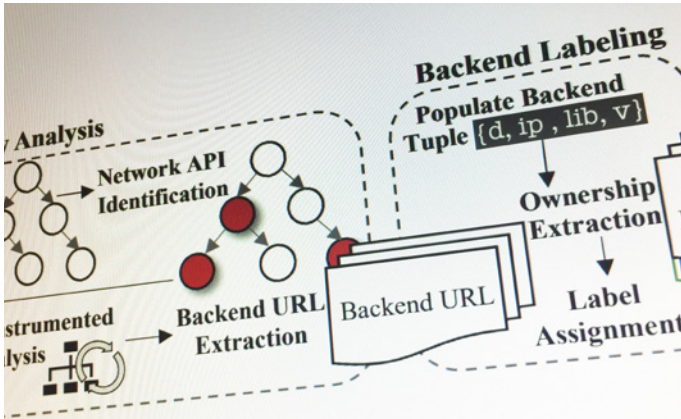

Smartphone Apps May Connect to Vulnerable Backend Cloud Servers

Cybersecurity researchers have discovered vulnerabilities in the backend systems that feed content and advertising to smartphone applications through a network of cloud-based servers that most users probably don't even know exists.



The team from Georgia Tech and The Ohio State University have identified more than 1,600 vulnerabilities in the support ecosystem behind the top 5,000 free apps available in the Google Play Store. The vulnerabilities, affecting multiple app categories, could allow hackers to break into databases that include personal information – and perhaps into users' mobile devices.

To help developers improve the security of their mobile apps, ECE Assistant Professor [Brendan Saltaformaggio](#) and his colleagues have created an automated system called SkyWalker to vet the cloud servers and software library systems. SkyWalker can examine the security of the servers supporting mobile applications, which are often operated by cloud hosting services rather than individual app developers.

The researchers identified three types of attack that could be made on the backend servers: SQL injection, XML external entity, and cross-site scripting. By taking control of these machines in the cloud, attackers could gain access to personal data, delete or alter information, or even redirect financial transactions to deposit funds in their own accounts.

The operators of vulnerable systems were notified of the findings. Concerns about who is responsible for securing those backend servers is one of the issues to come out of the study. To save app developers from having to do the security research they did, the researchers are offering SkyWalker, an analysis pipeline to study mobile backends. Developers will be able to submit their apps to SkyWalker at <https://mobilebackend.vet> and get a report on what it finds.

Tiny Vibration-Powered Robots Are the Size of the World's Smallest Ant

A research team led by ECE Assistant Professor [Azadeh Ansari](#) has created a new type of tiny 3D-printed robot that moves by harnessing vibration from piezoelectric actuators, ultrasound sources, or even tiny speakers. Swarms of these "micro-bristle-bots" might work together to sense environmental changes, move materials – or perhaps one day repair injuries inside the human body.

The prototype robots respond to different vibration frequencies depending on their configurations, allowing researchers to control individual bots by adjusting the vibration. Approximately two millimeters long – about the size of the world's smallest ant – the bots can cover four times their own length in a second despite the physical limitations of their small size.

Ansari and her team are working to add steering capability to the robots by joining two slightly different micro-bristle-bots together. Because each of the joined micro-bots would respond to different vibration frequencies, the combination could be steered by varying the frequencies and amplitudes.

Ansari, who holds the Sutterfield Family Early Career Professorship, and her team have built a "playground" in which multiple micro-bots can move around as the researchers learn more about what they can do. They are interested in developing micro-bots that can jump and swim, and they are looking at the collective behavior of ants and applying what is learned from them to these little robots.



[+] Development

The ECE Development Office cultivates and coordinates the School's fundraising efforts with industry, alumni, and other interested people and organizations. This group manages the [ECE Access Program](#), the [ECE Career Fair](#), and other networking and social activities to promote [alumni](#) and [corporate](#) involvement.

For more information about the School's fundraising activities, contact [Jeff Colburn](#), director of ECE Alumni Development, at 404.894.0274; [Anna Walker](#), director of ECE Alumni Development, at 404.894.2273; or [Etta Pittman](#), director of ECE Corporate Development, at 404.894.6888.



[FY 20 Donors]

We would like to thank the following corporations, organizations, and individuals for contributing \$7,083,234 to the School and its affiliates during FY 20.

INDIVIDUALS

Debbie & Moises Abadi
Deana & William Allen
Kathryn & Tony Alvarez
Anonymous
Susan & Brian Banner
Teresa & Harry Beck
Krithika Bhuvaneshwaran
William Branch
Suzy & Ben Briggs
H. Austin Brown
Anita Wathen-Brownlee
Gwyneth & Rob Butera
Nathan Camp
Domenic Carr
Arunabha Chatterjee
Mel Coker
Jeff Colburn
Harriett Coleman
Tom Collins
Laura & Dick Cureton
Sally & Todd Cutler
Wyndee & James DeBardelaben
Gina DeSimone & John Bauer
Anne Dlugos
Gail Dooley
Tom Dyal
Bonnie & Aldo Ferri
Nimisha & Kamal Garg
Jan & Tom Gaylord

Catherine Goodrich & Lee Gusler
Mary Gordon
Glenda & William Greer
Annette Gries & Patrick Wathen
Judy & John Haeger
Tracey & Holmes Hawkins
Gaye & Larry Heck
Amy & Shige Honjo
Pat & Ed Joy
Jennifer & Bill Kaduck
Rebecca & Fawad Khan
Christina & Alan Krauss
Ginny & Fred Krauss
Janice & Allen Lindsay
Nicole & Kenn MacKenzie
Joni Martin & Ray Vito
Norma McLees
Gayle & Fernando Mujica
Nannette Napier
Kari & William Newberg
April & Keith Ogboenyiya
Jani & James Pallis
Chad Patterson
Marilyn & John Peatman
Elizabeth & Claude Petty
Etta & Herman Pittman
Kathy & Randy Poliner
Dee & Jim Pope
Darrell Preble
Sheri & Matthew Prucka
Patrick Riley

Polly & Tom Sapitowicz
Shruti Sathe
Leslie & Ken Sibert
Paul Steffes
Janie & Jim Stratigos
Krithiga & Rajagopal Subramanian
Halina & Aleksander Szlam
Judith Vanderboom
Anna & Seth Walker
Pat & Roger Webb
Kay & Douglas Williams

CORPORATIONS, FOUNDATIONS, & ORGANIZATIONS

3M Worldwide
Accenture
Accenture - Atlanta
Airbus North America
Amazon.com, Inc.
Analog Devices, Inc.
Anaren Microwave, Inc.
AT&T, Inc.
Benevity Community Impact Fund of AEF
Boyce and Gail Dooley Family Foundation
Burns & McDonnell
CDM Smith
Chevron
Cisco Systems, Inc.

Community Foundation for Greater Atlanta
Comodo CA, Inc.
ConocoPhillips
Dynerics, Inc.
Eight Partners VC, LLC
ExxonMobil Corporation
Fidelity Investment Charitable Gift Fund
General Motors Corporation
Greater Cincinnati Foundation
Honeywell International, Inc.
Huxley Medical, Inc.
Inphi Corporation
Intel Corporation
International Paper Co.
IvySys Technologies, LLC
John and Mary Franklin Foundation, Inc.
John Deere World Headquarters
Kepler Computing, Inc.
Keysight Technologies
L3Harris Foundation
LyondellBasell Industries
Microsoft Corporation
Mindspaq @ Dover Corporation
Mitsubishi Electric Information Tech. Center America
National Corporate College Consultants, Inc.

Neophontics Corporation
Norfolk Southern Foundation
Otto & Jenny Krauss Charitable Fdn Trust
Phillips 66
Polaris Wireless, Inc.
Procter & Gamble Fund
Qualcomm, Inc.
Radio Club of America, Inc.
Robert Bosch Corporation
Salas OBrien South, LLC
Samsung Semiconductor, Inc.
Schwab Charitable Fund
Schweitzer Engineering Laboratories
Semiconductor Research Corporation
SHI International Corp.
Silicon Labs
Sixth Sensing, LLC
Southern Company Services
Tektronix, Inc.
Teledyne LeCroy
Texas Instruments, Inc.
The Boeing Company
The Marcus Foundation, Inc.
ThyssenKrupp Elevator
Vanguard Charitable Endowment Program
ViaSat

[+] Research Funding

ECE research funding for FY 20 totaled \$61,015,149 from grants and contracts.

Of this \$61 million total, 33% came from industry, 12% came from the National Science Foundation, 29% came from the U.S. Department of Defense, 10% from the National Institutes of Health, 1% from NASA, and 11% from other federal sources.

FY 20 Research Funding

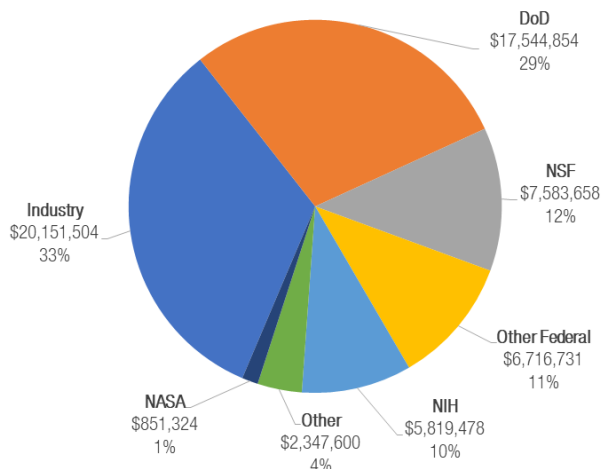

[+] Diversity and Inclusion

ECE Establishes Diversity and Inclusion Council

At the beginning of the fall 2020 semester, the School of ECE launched a Diversity and Inclusion Council focused on creating and sustaining a diverse and inclusive environment at the School level. The Council is made up of undergraduate students, graduate students, post-doctoral fellows, faculty members, staff members, and members of the ECE Advisory Board.

Teresa Askew, administrative manager and assistant to the school chair, has been appointed as chair by Magnus Egerstedt, Steve W. Chaddick School Chair, and will lead the activities of the Council.

The mission of the Council is as follows:

To create and sustain a diverse and inclusive environment where all employees (faculty and staff), students, and volunteers feel valued and respected in all departments, programs, and worksites, and to promote an academically enriching and supportive climate that allows all members to thrive and succeed.

Subcommittees within the Council were formed and each group developed strategic action plans that center on goals including: increasing the number of underrepresented students, faculty, and staff within the School; fostering a sense of inclusion with existing underrepresented community members; and growing a pipeline of prospective students from underrepresented K-12 student populations.

In addition to implementing these actions, the Committee will counsel ECE leadership regarding diversity and inclusion matters and will complement the role and activities of the College of Engineering Diversity & Inclusion Council.

“Embracing diversity in our field is not only the right thing to do, it is the mechanism by which we enhance our educational and research outcomes. Having a community made up of different experiences, viewpoints, and backgrounds opens us up to more creative ideas, innovative solutions to problems, and ultimately, an atmosphere centered around trust and respect that people want to be a part of,” said Egerstedt.

Contact Us

Georgia Institute of Technology
School of Electrical and Computer Engineering
777 Atlantic Drive NW
Atlanta, GA 30332-0250

Phone: 404.894.2901 | Fax: 404.894.4641

Stay Connected

 ece.gatech.edu

 [@GaTechSchoolofElectricalandComputerEngineering](https://www.facebook.com/GaTechSchoolofElectricalandComputerEngineering)

 [@GeorgiaTech_ECE](https://twitter.com/GeorgiaTech_ECE)

 [@GeorgiaTechECE](https://www.youtube.com/channel/UCGTECE)

 <http://bit.ly/GTECELinkedIn>

Acknowledgments

The 2019-2020 annual report of the School of Electrical and Computer Engineering is produced by Jackie Nemeth and Ashlee Gardner, of the ECE Communications Office, and Sarah Collins, College of Engineering Communications Office.

Additional ECE credits: Jeff Colburn, Linda Dillon, Tom Gaylord, Mark Richards, Justin Romberg.

Additional contributors: Georgia Parmelee, College of Engineering; Ben Wright, George W. Woodruff School of Mechanical Engineering; Ben Brumfield, Allison Carter, Rob Felt, Christopher Moore, Steven Norris, Peralte Paul, Joshua Stewart, John Toon, Brice Zimmerman, Institute Communications; Howard Shulman, Institutional Research and Planning.